

19604 67TH AVE NE ARLINGTON, WA 98223
 (360) 435-5531 WWW.CUZCONCRETE.COM

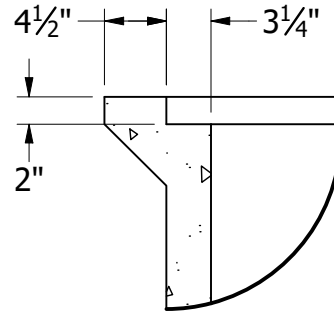

**DETAIL B
 DIMENSIONS TYP**

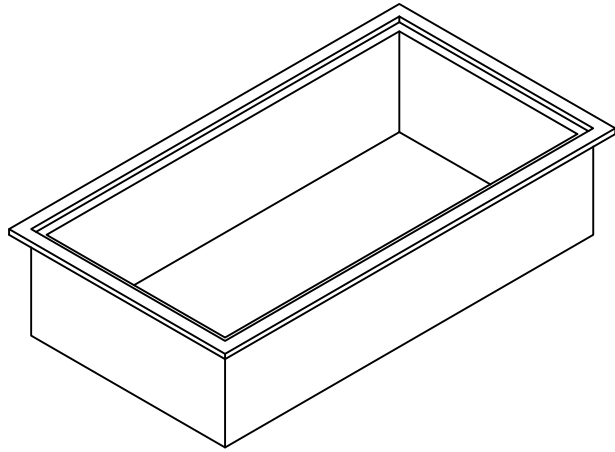
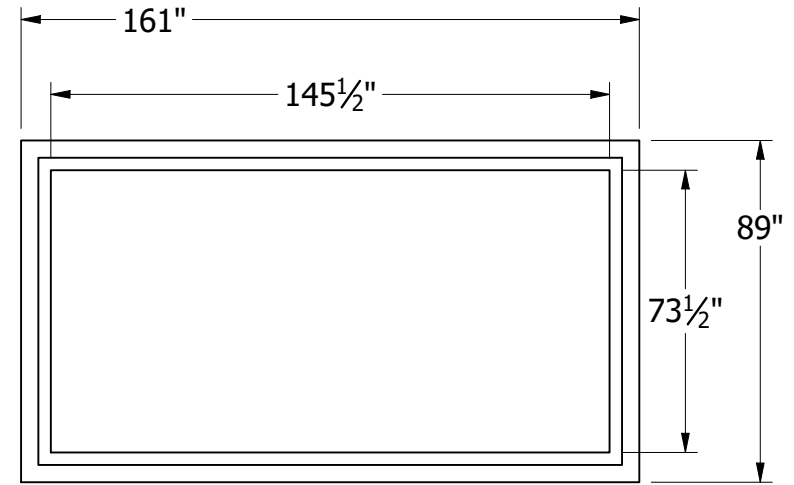

TOP VIEW

H	Weight (lb)
12"	2400
24"	3900
36"	5450

GENERAL NOTES:

- CONCRETE 28 DAY COMPRESSIVE STRENGTH FC: 4000PSI
- REBAR #4 ASTM A-615 GRADE 60
- DL: 36IN EARTH COVER
- LL: 25 SNOW
- SOILS: 2000PSI
- WATER PRESSURE: 62.4PSF
- JOINT MATERIAL MEETS FEDERAL SPECS. SS-S-002I

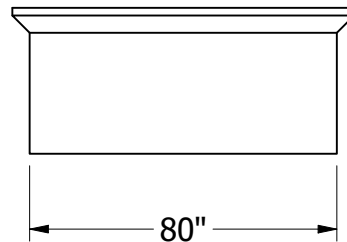

LEFT VIEW

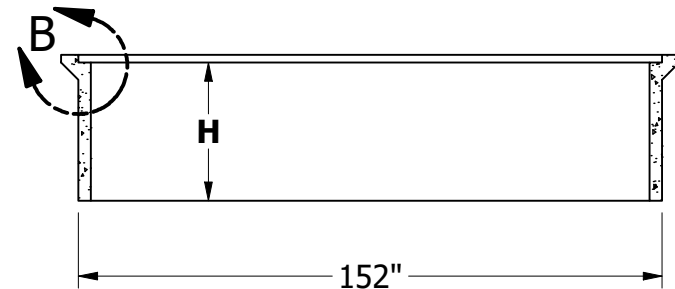

**FRONT SECTIONAL
 VIEW**