

19604 67TH AVE NE ARLINGTON, WA 98223  
 (360) 435-5531 WWW.CUZCONCRETE.COM

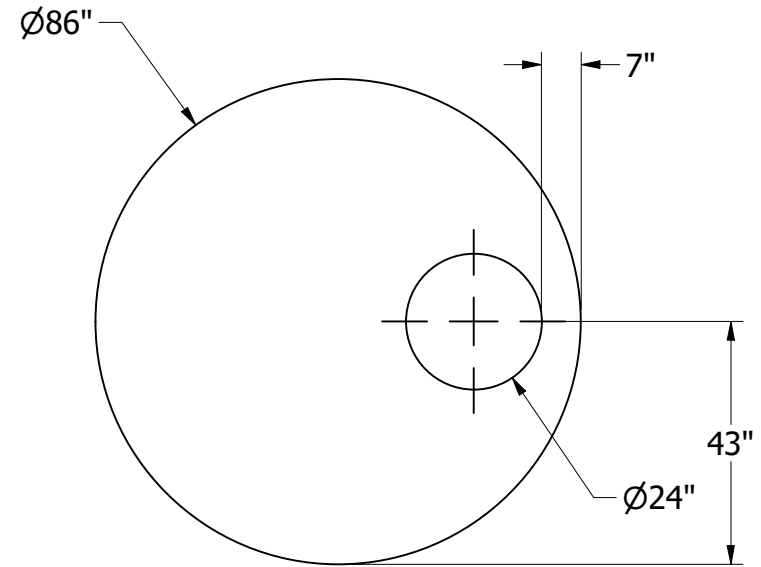
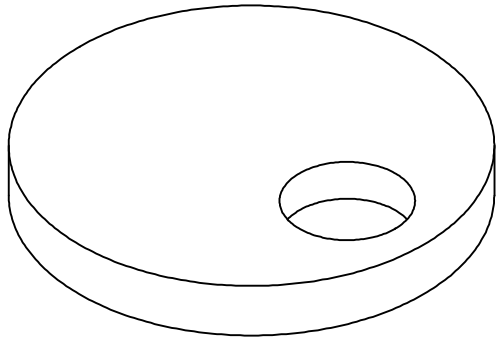

**TOP VIEW**

GENERAL NOTES:

- CONCRETE 28 DAY COMPRESSIVE STRENGTH FC: 4000PSI
- AREA OF STEEL: .18 IN<sup>2</sup>
- WEIGHT: 4,250 LBS
- REBAR #4 ASTM A-615 GRADE 60
- DL: 36IN EARTH COVER
- LL: 25 SNOW
- SOILS: 2000PSI
- WATER PRESSURE: 62.4PSF
- FLEXIBLE PIPE ADAPTER PRESS SEAL 4IN CAST-A-STEEL
- JOINT MATERIAL MEETS FEDERAL SPECS. SS-S-002I

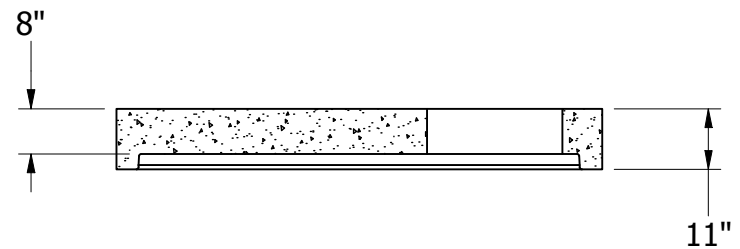

**FRONT SECTIONAL VIEW**