

19604 67TH AVE NE ARLINGTON, WA 98223
 (360) 435-5531 WWW.CUZCONCRETE.COM

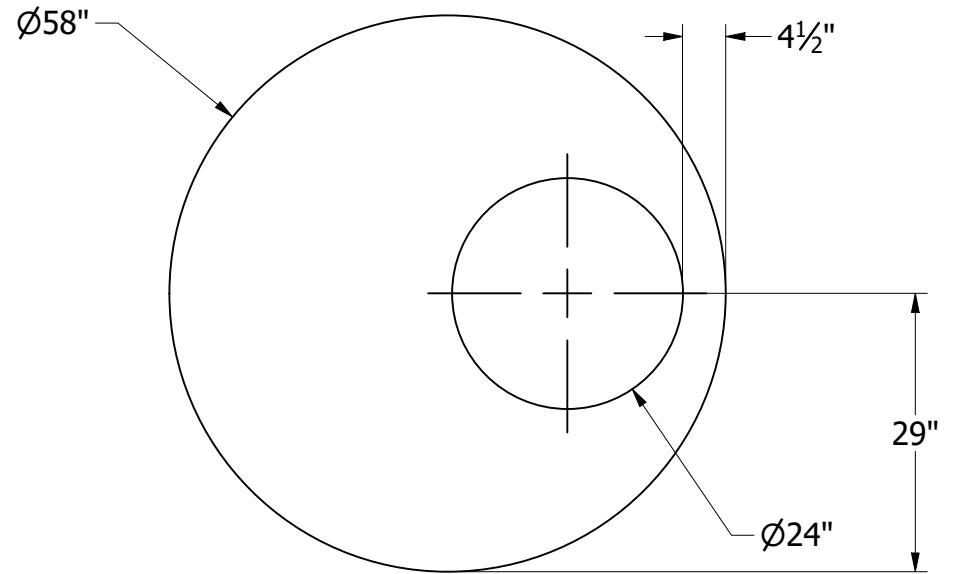
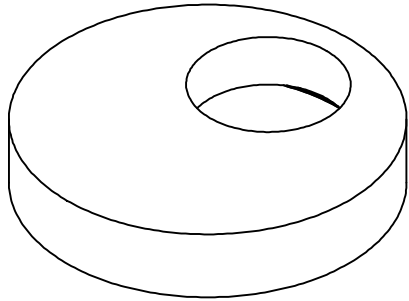

TOP VIEW

GENERAL NOTES:

- AREA OF STEEL: .12 IN²
- WEIGHT: 1,800 LBS
- CONCRETE 28 DAY COMPRESSIVE STRENGTH FC: 4000PSI
- REBAR #4 ASTM A-615 GRADE 60
- DL: 36IN EARTH COVER
- LL: 25 SNOW
- SOILS: 2000PSI
- WATER PRESSURE: 62.4PSF
- FLEXIBLE PIPE ADAPTER PRESS SEAL 4IN CAST-A-STEEL
- JOINT MATERIAL MEETS FEDERAL SPECS. SS-S-002I

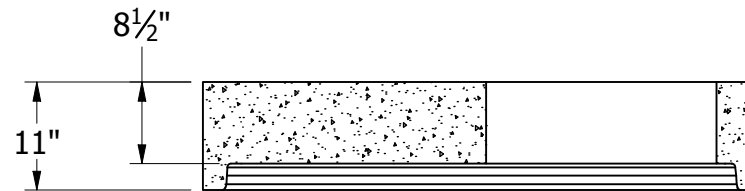

FRONT SECTIONAL VIEW